

Bar Manifold D03 (Size 6) Series Circuit Normal Flow

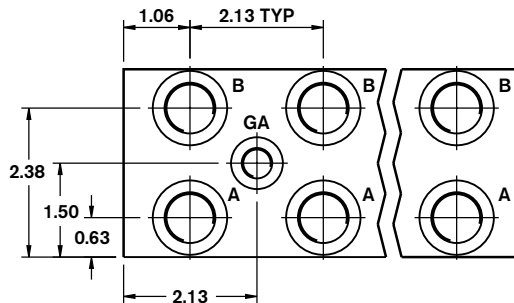

Revision	= XX
Number of Station	= 02-08
Material	= A = D
Valve Spacing 2.13"	= 2

Omit =	No Options
RCI =	Relief Cavity Industry Common 10-2
RCS =	Relief Cavity Sun T-10A (P in nose)
12 =	SAE Threaded Ports
	P&T: 7/8-14 SAE-10
	A&B: 3/4-16 SAE-8
	GA: 9/16-18 SAE-6

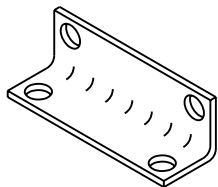
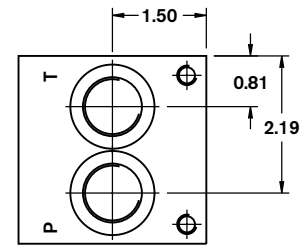
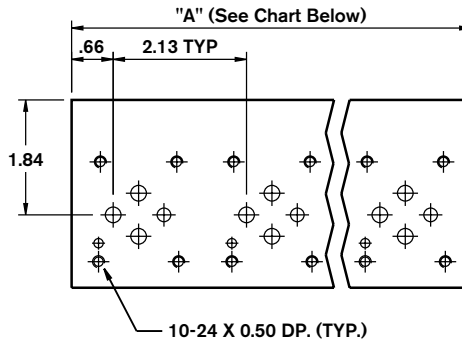
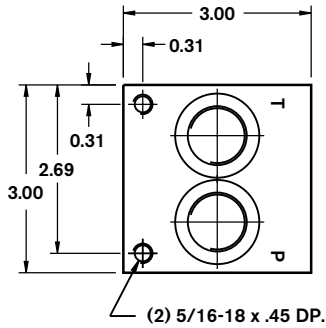
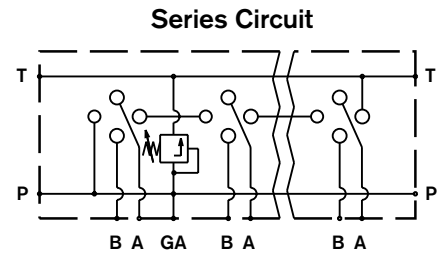
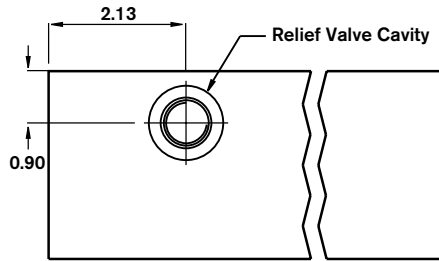
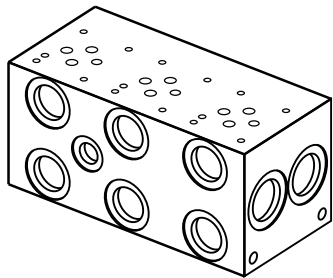

Number of Stations	02	03	04	05	06	07	08
Dim. "A"	4.25	6.38	8.50	10.63	12.75	14.88	17.00
Approx. Weight AL (lbs)	4	6	8	9	11	13	15
Approx. Weight DI (lbs)	10	15	20	25	30	35	40

All dimensions in inches